

TL armaturen Ex de
Fluorescent lighting fixtures Ex de

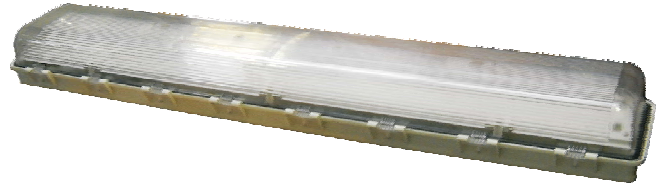

Lichtkarakteristiek voor 1000 lm flux
Polar curves for a 1000 lm flux

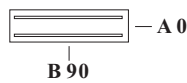
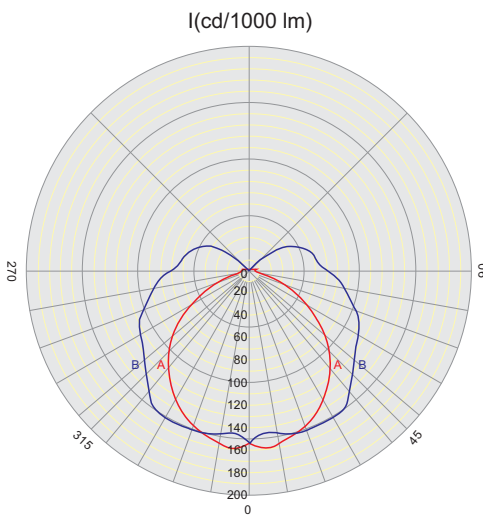

type Z0865 - 2 x 18 Watt

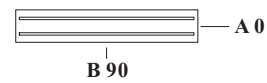
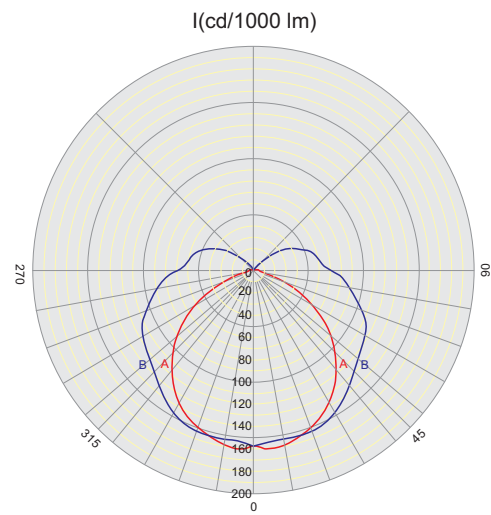

type Z0866 - 2 x 36 Watt

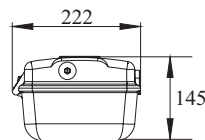

Afmetingen
Dimensions

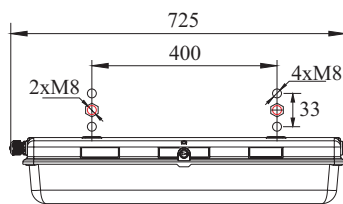

type Z0865 - 2 x 18 Watt

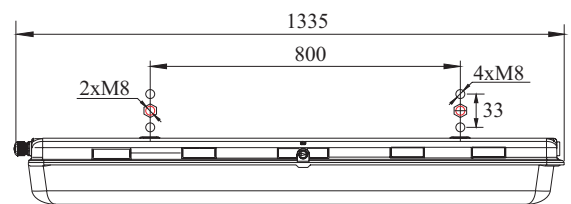

type Z0866 - 2 x 36 Watt

Technische informatie:

Ex markering: II 2G Ex deq IIC T4
 II 2D Ex DIP A21 Ta T120°C
 Geschikt voor zone 1, 2, 21 en zone 22
 Omgevingstemperatuur: $-25^{\circ}\text{C} \leq \text{Ta} \leq 40^{\circ}\text{C}$
 Beschermingsgraad: IP65
 Spanning: 230 VAC - 50/60Hz.
 Lamphouder: Bi-pin - G13
 Kabelingangen: 3xM25
 Aansluitingen: 4 mm²
 Materiaal behuizing: glasvezelversteekt polyester
 Materiaal kap: polycarbonaat

Conform de standaards: EN60079

Technical data:

Ex mark: II 2G Ex deq IIC T4
 II 2D DIP A21 Ta T120°C
 Can be used in zone 1, 2, 21 and zone 22
 Ambient temperature: $-25^{\circ}\text{C} \leq \text{Ta} \leq 40^{\circ}\text{C}$
 Degree of protection: IP65
 Voltage: 230 VAC - 50/60Hz.
 Lampholder: Bi-pin - G13
 Cable entries: 3xM25
 Connections: 4 mm²
 Material body: glass fibre reinforced polyester
 Material cover: polycarbonate

Meets the standards: EN60079

Afbeelding Illustration	Vermogen Power	Stroom Current	Gewicht Weight	Type
	2 x 18W	max. 0.2A	5.0 kg	Z0865 / 218
	2 x 36W	max. 0.39A	7.9 kg	Z0866 / 236

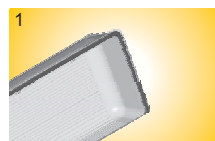
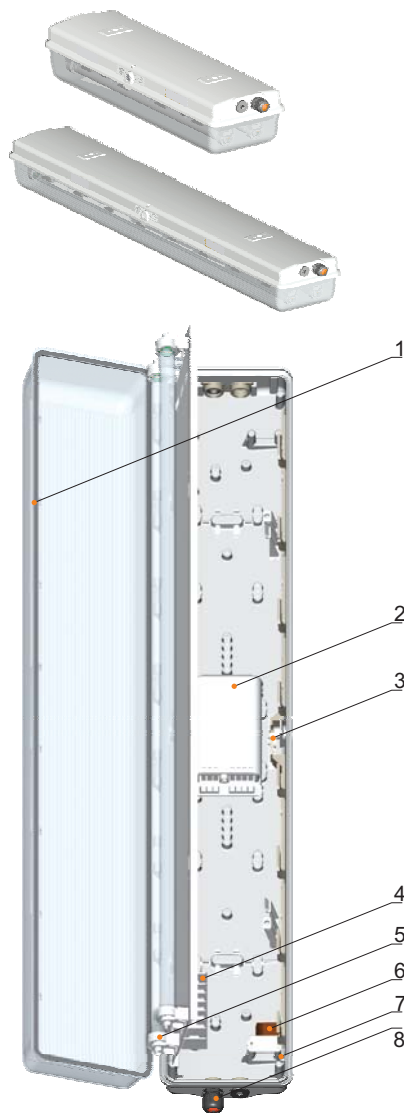

1
Afdichting t.b.v. beschermingsgraad IP 65
Gasket for protection degree IP65



2
Elektronische ballast
Electronic ballast



3
Centraal sluitsysteem
Central lock system



4
Aansluitklemmen
Terminals

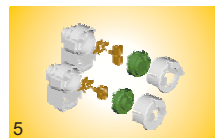

5
Lamphouder Bi-pin - G13
Lampholder Bi-pin - G13



6
Veiligheidsschakelaar, schakelt spanning uit bij openen deksel
Safety switch, disconnects power when cover is opened



7
Vergrendeling centraal sluitsysteem, waardoor het centraal sluitsysteem niet te bedienen is zodra de kap geopend wordt.

Interlocking device central lock system, which ensures that the central lock system cannot be operated when cover is opened.



8
Kabelwartel en plug - Ex e
Cable gland and plug - Ex e

TL noodverlichtingsarmaturen Ex de Fluorescent emergency lighting fixtures Ex de

Technische informatie:

Ex markering: Ⓜ II 2G Ex deq IIC T4
 Ⓜ II 2D Ex DIP A21 Ta T120°C
 Geschikt voor zone 1, 2, 21 en zone 22
 Omgevingstemperatuur: $-25^{\circ}\text{C} \leq \text{Ta} \leq 40^{\circ}\text{C}$
 Beschermingsgraad: IP65
 Spanning: 230 VAC - 50/60Hz
 Laadtijd: 24 uur
 Noodverlichting duur: >120 min.
 Lamphouder: Bi-pin - G13
 Kabelingen: 3xM25
 Aansluitingen: 4 mm²
 Materiaal behuizing: glasvezelversterkt polyester
 Materiaal kap: polycarbonaat

Conform de standaards: EN60079

Technical data:

Ex mark: Ⓜ II 2G Ex deq IIC T4
 Ⓜ II 2D DIP A21 Ta T120°C
 Can be used in zone 1, 2, 21 and zone 22
 Ambient temperature: $-25^{\circ}\text{C} \leq \text{Ta} \leq 40^{\circ}\text{C}$
 Degree of protection: IP65
 Voltage: 230 VAC - 50/60Hz.
 Charging time: 24 hour
 Emergency light duration: > 120 min.
 Lampholder: Bi-pin - G13
 Cable entries: 3xM25
 Connections: 4 mm²
 Material body: glass fibre reinforced polyester
 Material cover: polycarbonate

Meets the standards: EN60079

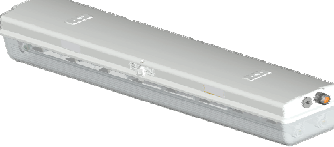
Afbeelding Illustration	Vermogen Power	Stroom Current	Gewicht Weight	Type
	2 x 18W (1x18W)	max. 0.2A	6.8 kg	Z0865 / 218 YJ
	2 x 36W (1x36W)	max. 0.39A	9.9 kg	Z0866 / 236 YJ

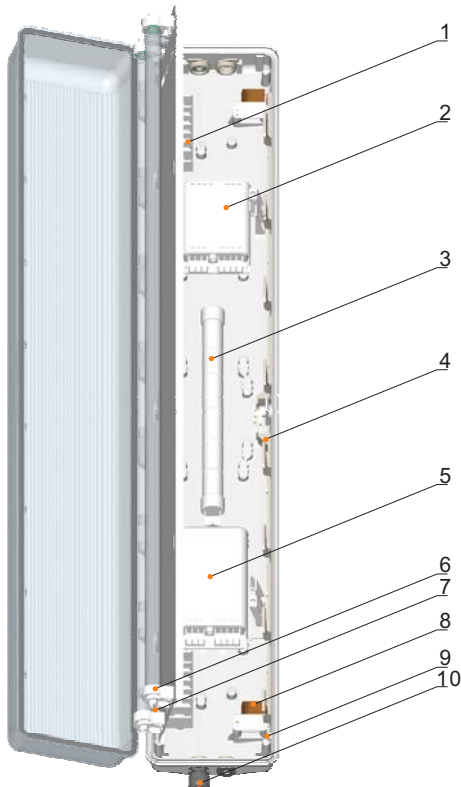

Aansluitklemmen
Terminals



Batterij
Battery pack



Invertor t.b.v. batterij
Invertor for battery



3 stuks indicatieleds
3 pieces LED indicators



Vergrendeling centraal sluitsysteem, waardoor het centraal sluitsysteem niet te bedienen is zodra de kap geopend wordt.
Interlocking device central lock system, which ensures that the central lock system cannot be operated when cover is opened.

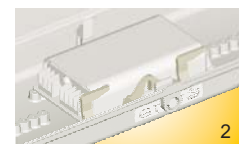

Elektronische ballast module
Electronic ballast module



Centraal sluitsysteem
Central lock system

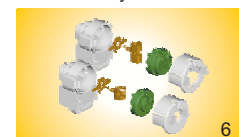

Lamphouder Bi-pin - G13
Lampholder Bi-pin - G13



Veiligheidsschakelaar, schakelt spanning uit bij openen deksel
Safety switch, disconnects power when cover is opened



Kabelwartel en plug - Ex e
Cable gland and plug - Ex e

TL armaturen - toebehoren Fluorescent light fitting - accessories

Afbeelding Illustration	Omschrijving Description	Materiaal Material	Unit	Type
	Plafondbeugel Ceiling bracket	Gegalvaniseerd staal Galvanized steel	Set	D621
		RVS 304 Stainless Steel 304	Set	D621/304
	Draadeind M6 Pendant M6	Gegalvaniseerd staal Galvanized steel	Set	D622
	M8 oogbout met ketting M8 ring bolt with chain	Gegalvaniseerd staal Galvanized steel	Set	D623
	Wandbeugel Wall bracket	Geplastificeerd staal Plastic covered steel	Set	D624
	Aardplaat 2xM25 Earthing plate 2xM25	Koper Copper	Stuks Piece	D8714/2-M25
 Pijpbeugel Pipe clamp	Pijp/pipe 1 1/4" = 42 ~ 45mm	Gegalvaniseerd staal Galvanized steel	Set	J200
		RVS 304 Stainless Steel 304	Set	J200/304
	Pijp/pipe 1 1/2" = 47 ~ 50mm	Gegalvaniseerd staal Galvanized steel	Set	J300
		RVS 304 Stainless Steel 304	Set	J300/304
	Pijp/pipe 2" = 59 ~ 62mm	Gegalvaniseerd staal Galvanized steel	Set	J400
		RVS 304 Stainless Steel 304	Set	J400/304

Afmetingen Dimensions

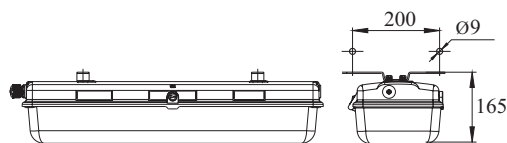

Montage met plafondbeugels
Mounting with ceiling brackets

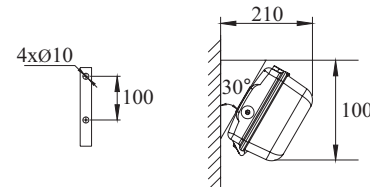

Montage met wandbeugel
Mounting with wall bracket

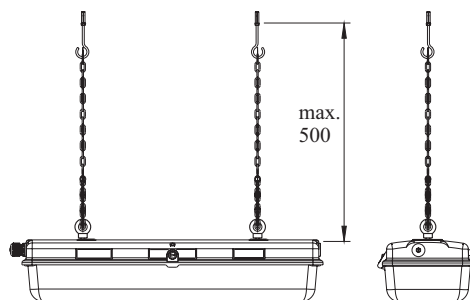

Montage met kettingen
Mounting with chains

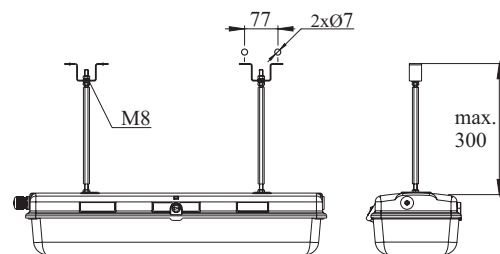

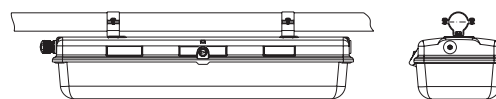

Montage met draadeind M6
Mounting with pendant M6

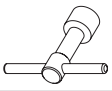

Montage met pijpbeugels
Mounting with pipe clamps

TL armaturen - reserve onderdelen Fluorescent lighting fixtures - spare parts

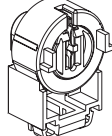
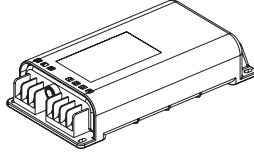
Afbeelding Illustration	Omschrijving Description	Unit	Type
	M8/SW13 Sleutel M8/SW13 Key spanner	Stuks Piece	D601
	Veiligheidsschakelaar Safety switch	Stuks Piece	Z0207-1
	Lamphouder Bi-pin - G13 Lampholder Bi-pin - G13	Stuks Piece	Z0403/G13
	Elektronische ballast 2x18W Electronic ballast 2x18W	Stuks Piece	Z0818/2x18W
	Elektronische ballast 2x36W Electronic ballast 2x36W	Stuks Piece	Z0818/2x36W

TL noodverlichtingsarmaturen - reserve onderdelen Fluorescent emergency lighting fixtures - spare parts

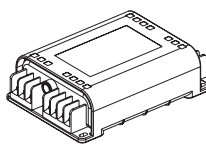
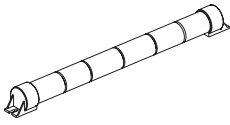
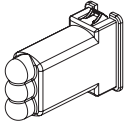
Afbeelding Illustration	Omschrijving Description	Unit	Type
	Invertor t.b.v. batterij 2x18W Invertor for battery 2x18W	Stuks Piece	Z0818/18W YJ
	Invertor t.b.v. batterij 2x36W Invertor for battery 2x36W	Stuks Piece	Z0818/36W YJ
	Batterij 4,5Ah/6V - 2x18W Battery 4.5Ah/6V - 2x18W	Stuks Piece	Z0819/4.5-6
	Batterij 4,5Ah/7,2V - 2x36W Battery 4.5Ah/7.2V - 2x36W	Stuks Piece	Z0810/4.5-7
	Indicatieleds LED indicators	Stuks Piece	Z0802