



Operation and instruction manual
Ex e Junction and Controlboxes type INDEX.E.X

Stainless Steel 304 and 316



INDEX ELEKTRO BV
Harregatplein 15
3214 VP Zuidland
Netherlands



T. +31(0)181 452120
<http://www.indexelektro.nl>
email Sales@indexelektro.nl



Purpose of these instructions

Working in hazardous areas, the safety of personnel and plant depends on complying with all relevant safety regulations. Assembly and maintenance staff working on installations therefore have a particular responsibility. They require precise knowledge of the applicable standards and regulations. These instructions give a brief summary of the most important safety measures. It supplements the corresponding regulations which the staff must study.



SAFETY INSTRUCTIONS

Use the explosion-proof box only for its intended purpose. Explosion-proof boxes are not suitable for Zone 0 hazardous areas! Incorrect or impermissible use or non-compliance with these instructions invalidates our warranty provision. No changes to the device impairing its explosion protection are permitted. Use the explosion-proof box only if it is clean and undamaged. Any damage can invalidate the Ex-protection.

Observe the following during installation and operation:

- National safety regulations
- National accident prevention regulations;
- National installation regulations(e.g. IEC 60079-14);
- Generally recognized technical regulations;
- Safety guidelines in these operating instructions;
- Characteristic values given on explosion-proof switch module.

Applicable scope

Transport and storage in original packaging only. National safety and installations regulations and the generally accepted rules of engineering practice must be observed when mounting and operating this equipment.

Technical data

Ex mark: Ex II 2G Ex e.....[ia....] II Gb
 Ex II 2D Ex tb IIIC Db

possible explosion-proof protection - d, e, m, ia / ib / etc.
 possible temperature class - T4, T5, T6 - 85°C, 100°C, 135°C

Can be used in zone 1,2, 21 en 22
 Ambient temperature: $-20^{\circ}\text{C} \leq T_a \leq 40^{\circ}\text{C}$
 Optional temperature: $-40^{\circ}\text{C} \leq T_a \leq 80^{\circ}\text{C}$
 Degree of protection: IP65 / IP66
 Certificate CML 18ATEX 3276X
 IECEx CML 18.0132X

Conformity to standards

The explosion-proof box is designed and manufactured according to standard of ISO 9001. The explosion-proof box is in conformity with ATEX directive and the standards IEC60079, EN60079 and IEC61241, EN61241

Model and implication of INDEX.E

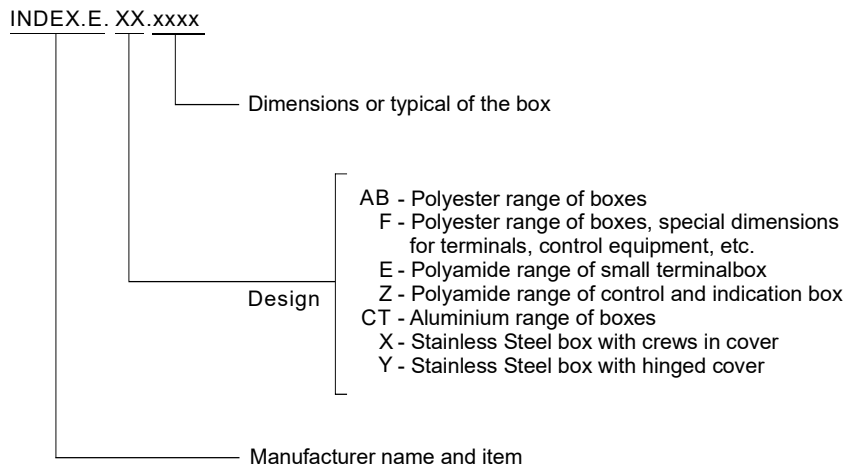



INDEX.E.X - Stainless Steel EXe boxes

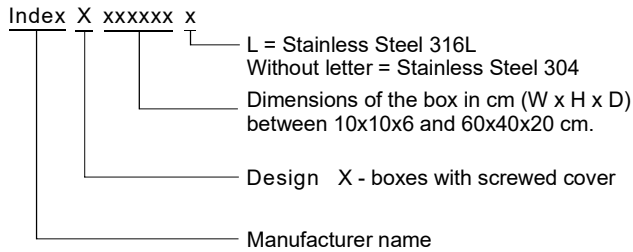

Ex mark: Ⓜ II 2G Ex eia. IIC T4..T6 Gb
 Ⓜ II 2D Ex tb III T6 85°... 135°C Db
 possible explosion-proof protection - d, e, m, n, ia / ib / etc.
 possible temperature class - T4, T5, T6 - 85°C, 100°C, 135°C
 Can be used in zone 1,2, 21 en 22
 Ambient temperature: $-20^{\circ}\text{C} \leq \text{Ta} \leq 40^{\circ}\text{C}$
 Option temperature: $-40^{\circ}\text{C} \leq \text{Ta} \leq 60^{\circ}\text{C}$
 Degree of protection: IP65 (66)
 Material: Stainless Steel 304
 Optional material: Stainless Steel 316



INDEX

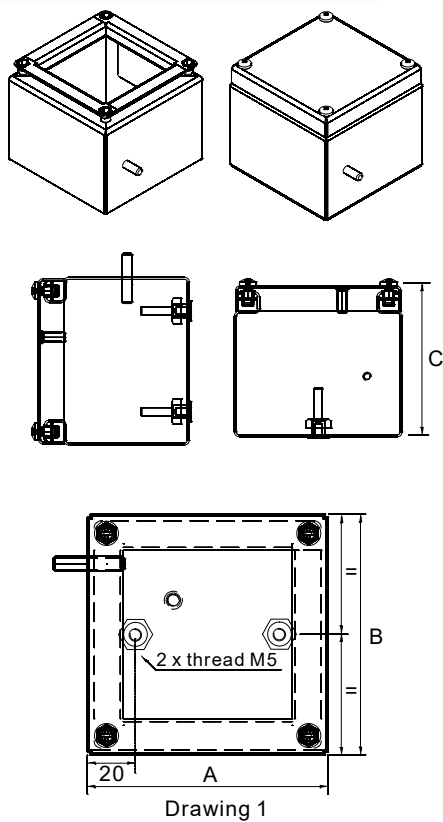

Behuizing type Enclosure type	Afmetingen - Dimensions (mm)			
	Extern External			Montage Fixing
	A	B	C	Drawing
INDEX.X.101006	100	100	60	1
INDEX.X.102006	200	100	60	1
INDEX.X.101009	100	100	90	1
INDEX.X.102009	200	100	90	1
INDEX.X.121209	120	120	90	1
INDEX.X.151509	150	150	90	1
INDEX.X.152512	150	250	120	1
INDEX.X.153009	150	300	90	1
INDEX.X.161609	160	160	90	1
INDEX.X.203012	300	150	90	1
INDEX.X.204016	300	200	120	2
INDEX.X.206016	400	200	160	2
INDEX.X.304016	600	200	160	2
INDEX.X.305016	400	300	160	2
INDEX.X.406016	500	300	160	2

RVS behuizing type INDEX.X
Stainless Steel enclosure type INDEX.X

L = Stainless Steel 316, without = Stainless Steel 304

Can be supplied on request in sizes between 100 x 100 x 60 mm and 600 x 400 x 160 mm.

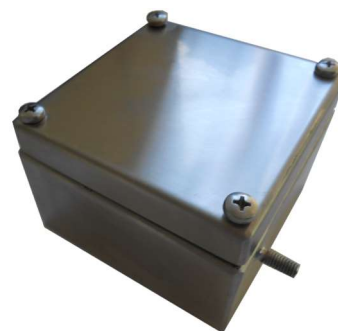
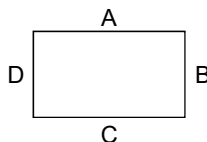

Enclosure type	Cable glands in side A								Cable glands in side B						
	M16	M20	M25	M32	M40	M50	M63	M75	M16	M20	M25	M32	M40	M50	M63
INDEX.X.101006	3	2	1						2	1					
INDEX.X.102006	6	4	2						2	1					
INDEX.X.101009	3	3	2	1					2	2					
INDEX.X.102009	16	14	8	4	3				2	2					
INDEX.X.121209	6	5	2	1	1				4	3	1				
INDEX.X.151509	10	8	4	2	1				8	6	4	2	1		
INDEX.X.152512	35	35	20	11	9	4	2	2	12	10	8	5	2	1	
INDEX.X.153009	24	20	12	7	6	2			8	6	4	2	1		
INDEX.X.161609	12	10	6	3	2	1			8	6	4	2	2		
INDEX.X.203012	35	30	18	10	8	4	3		16	12	10	7	3	1	1
INDEX.X.204016	46	44	26	15	12	6	4	3	24	16	12	8	4	2	1
INDEX.X.206016	68	60	36	20	15	8	6	4	24	16	12	8	4	2	1
INDEX.X.304016	46	44	26	15	12	6	4	3	24	18	15	10	4	2	1
INDEX.X.305016	56	62	31	19	13	7	5	3	24	18	15	10	4	2	1
INDEX.X.406016	68	60	36	20	15	8	6	4	44	40	24	13	10	4	2

Stainless Steel terminal boxes Ex e type INDEX.X - terminals

	Enclosure type	Max. number of connections									Max power in Watt			
											T.Amb:-20°C,+40°C		T.Amb:-40°C,+60°C	
		2.5mm ²	4mm ²	6mm ²	10mm ²	16mm ²	35mm ²	50mm ²	70mm ²	95mm ²	T5	T6	T5	T6
	INDEX.X.101006	10	10								16	12	11	7
	INDEX.X.102006	26	20								27	21	18	11
	INDEX.X.101009	10	10								18	14	11	7
	INDEX.X.102009	26	20								30	24	20	12
	INDEX.X.121209	15	14	8							20	15	13	8
	INDEX.X.151509	22	17	11	6	4	4				34	25	23	14
	INDEX.X.152512	40	34	25	18	15	10				62	46	41	26
	INDEX.X.153009	50	40	30	23	20	12	6	6		62	46	41	26
	INDEX.X.161609	24	19	12	10	8	8				36	27	24	15
	INDEX.X.203012	48	40	30	23	20	12	16	14	12	86	65	58	36
	INDEX.X.204016	70	40	48	30	28	20	20	16	12	109	95	84	53
	INDEX.X.206016	100	58	64	48	44	32	16	16	12	156	134	119	74
	INDEX.X.304016	140	86	92	30	28	20	16	16	12	167	125	111	70
	INDEX.X.305016	170	116	108	38	36	26	20	19	15	200	150	133	83
	INDEX.X.406016	200	144	128	96	88	64	32	32	24	288	216	192	120

Maximum number of connections depends on current

Complete composite enclosures with ATEX or IECEx certificate can only be provided if all work is carried out by employees of INDEX ELEKTRO in the INDEX ELEKTRO workshop or service office.

Ex mark: Ex II 2G Ex e.....ia.... II Gb
 Ex II 2D Ex tb IIIC Db

possible explosion-proof protection - d, e, m, n, ia / ib / etc.
 possible temperature class - T4, T5, T6 - 80°C, 100°C, 130°C

Can be used in zone 1,2, 21 en 22
 Ambient temperature: $-20^{\circ}\text{C} \leq T_a \leq +40^{\circ}\text{C}$
 Option temperature: $-40^{\circ}\text{C} \leq T_a \leq +80^{\circ}\text{C}$



Following Ex certified components can be built inside Ex e boxes

- Pushbuttons series and contact - type Z0201 o.e.
- Pilot lights modules - type Z0202 o.e.
- Potentiometer modules - type Z0203 o.e.
- Ammeter, or Voltmeter - type Z0205 o.e.
- Illuminated pushbutton module - type Z0203 o.e.
- Fuses with holder - type Z0509 o.e.
- Fuses for direct mounting - type Z0804 o.e.
- Main switches - type Z0513 o.e.
- Circuit breakers - type Z0511 o.e.
- Earth leakage circuit breakers - type Z0511 o.e.
- Motor protectionswitches - type Z0512 o.e.
- Thermal relays - type Z0512 o.e.
- Contactors and reversing contactors - type Z0512 o.e.
- Auxiliary relays - type Z0512 o.e.
- Timer relays - type Z0512 o.e.
- Transformers - type Z0516 o.e.
- Buzzer (with or without flash) type Z1208 or TP-MS75M-83 o.e.
- Hour counter type - TP-DS64A o.e.
- Heaters - type LP or SM o.e.
- Thermostat - type H o.e.
- Socket outlets - type Z025x, type Ma.xxxxxx. o.e.
- Windows type Z - 8002/x
- Coupling units type Z8004 / Z8005 / Z8006 o.e.
- Terminals Ex e - as Phoenix UT, UK or MBK type, Weidmuller WDU or WDE type, Wago etc
- Earthbars
- Earth and connection pin like Z0307 or Z0303

- Cable gland, reducer etc. polyamide series IE2, Z0220 o.e.
- Cable gland, reducer etc. brass series IE3, Z0221, INDEX.IR, o.e.
- Cable gland, reducer etc. Stainless Steel series INDEX.IR o.e.
- Breathers

- Ex d boxes series INDEX.B or INDEX.C (certified for zone 1)
- Ex d boxes - KOP, (certified for zone 1)

- Other materials - zone 1 certified like display's, computers etc.

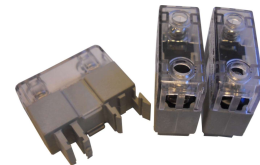



Materials without Ex certification like

- Wiring
- Wiring duct
- Tubing
- Windows
- Dinrail and mounting rail
- Screws, bolts and nuts
- Cabling
- Mounting brackets
- Tagplates
- Bulkhead Couplings
- etc.

Materials only for zone 2 declaration.

- Barriers, amplifiers etc - Ex n certified
- PLC - Ex n certified
- Displays or HMI's - Ex n certified
- Sockets outlets - Ex n certified
- Other materials zone 2 certified

See for more information product manuals from each item.



Safety and Maintenance Instruction

This Safety Instruction is meant for skilled electricians and instructed personnel in accordance with national legislation, including the relevant standards and, where applicable, in accordance with IECEx 60079 and EN60079 on electrical apparatus for explosive atmosphere. Read carefully this instruction before installation or maintenance.

After each opening (at least once a year for inspection) the following points must be checked/performed:

- Compliance with permitted ambient temperatures;
 - Damages on the box
 - Damages on the gaskets
 - Clean upper dust and avoid dust accumulating.
1. Enclosures must be installed and maintained in accordance with all standards regarding electrical installations in hazardous areas classified for explosive gas and/or dust atmospheres.
 2. Avoid any dust accumulation.
 3. The boxes must not be operated in zone 0 hazardous areas.
 4. Ambient temperature, maximum voltage and maximum current must not exceed mentioned values on the tagplate.
 5. Changes of the design and modifications to the equipment are not permitted.
 6. The boxes shall be operated as intended and only in undamaged and perfect condition.
 7. If box or part of box is damaged, the power has to be disconnected immediately.
Contact Index Elektro BV for further instructions. It is not allowed to repair the box without the written permission of Index Elektro BV.
 8. Repairs may only be carried out by qualified electrician from INDEX ELEKTRO BV.
 9. All operations of installation, replacement or inspection must **not** be performed when electrical circuit is alive.
 10. All technical data indicated on the tag plate of the box have to be observed.
Also all other information on tag plate or extra text plate has to be respected.
 11. Accessories used for cable entries must meet IECEx 60079 and EN 60079 standards.
Their minimum protection must be IP54. When gaskets are used to maintain raintightness, be sure the gaskets are mounted in their adequate locations.
 12. All unused holes for cable entries etc., have to be closed with appropriate plugs, which are Atex / IECEx certified.
 13. Handle carefully all joint parts so to avoid damaging coupling surface.
 14. If cover of Ex box is fitted with bolts, all bolts must be present and completely screwed.
(For tightening moment of bolts of Ex box see the sheets before, if one of these conditions is not regarded, the enclosure has to be disconnected from power supply immediately, because the enclosure is not explosion-proof. In case of lost bolts we recommend to replace them with new screws. Use screws with same diameter, pitch and length of thread.
 15. Disconnect power immediately if a coloured lens of a signalling light is damaged or broken, until a new lens has been fitted.
 16. All Ex enclosures with external earth bolt must be connected to earth with an external earth conductor with adequate cross section (at least 4 mm²).
 17. All metal parts in and outside the box must be connected to earth (such as cable glands etc.).
 18. When a metal cable gland used in polyester or polyamide boxes an external earth bolt is required.
 19. The respective valid national regulations shall be observed



Label 1 - Small boxes
see tabel

60			
INDEX		CE 2503	
Harregatplein 15 - 3214 VP Zuidland - The Netherlands T +31(0)181 452120 - www.indexelektro.nl - Sales@indexelektro.nl			
Type	INDEX.E.AB.	Year	2019
Ref.no.		T.Amb.	-40°C to +60°C
Volt	60	Max Protect	IP66
Amp	1	Max Tightening cover	0,6 Nm
II2G Ex eb ia IIC T6 Gb CML 18ATEX3276X		II2D Ex tb IIIC T80°C Db IECEX CML18.0132X	
Do not open when energised After de-energisation wait 15 min. before opening			
		42	

Label 2 - Standard boxes
see tabel

76			
INDEX		CE 2503	
Harregatplein 15 - 3214 VP Zuidland - The Netherlands T +31(0)181 452120 - www.indexelektro.nl - Sales@indexelektro.nl			
Type	INDEX.E.F.	Year	2019
Ref.no.		T.Amb.	-20 °C to +40 °C
Volt		Max Protect	IP 65
Amp		Max Tightening cover	0,8 Nm
II2G Ex eb ia IIC T6 Gb CML 18ATEX3276X		II2D Ex tb IIIC T80°C Db IECEX CML18.0132X	
Do not open when energised After de-energisation wait 15 min. before opening			
		58	

- Type = Index Elektro types as per table
- Ref.no. = Index Elektro order number + identification number (as per list) - e.g. 170123 - 345123
- Volt = Max. voltage
- Amp = Max. current
- Year = Year of construction
- T.Amb. = Ambient temperature
- Protect = IP range



Enclosure type	Label
INDEX.E.X.101006.□	1
INDEX.E.X.102006.□	1
INDEX.E.X.101009.□	1
INDEX.E.X.102009.□	1
INDEX.E.X.151509.□	2
INDEX.E.X.153009.□	2
INDEX.E.X.203012.□	2
INDEX.E.X.204016.□	2
INDEX.E.X.206016.□	2
INDEX.E.X.304016.□	2
INDEX.E.X.305016.□	2
INDEX.E.X.406016.□	2
INDEX.E.X.xxxxxx. □	2

Note - □ L = Stainless Steel 316L Without letter = Stainless Steel 304